

Applications

- Cereal
- Coffee/Tea
- Confectionery
- Pasta
- Pet Foods
- Salt/Spices
- Snack Foods/Nuts
- Ammunition
- Batteries
- Carbon Black
- Catalyst
- Chemical
- Fertilizer
- Glass Cullet
- Metal Powders

Features & Benefits

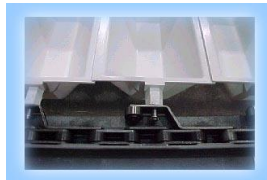

- Heavy duty chains for long-life durability and reliability
- Various construction materials for chains to meet specific process applications
- Optional automatic chain cleaning (ChainCare) for maximum cleanliness

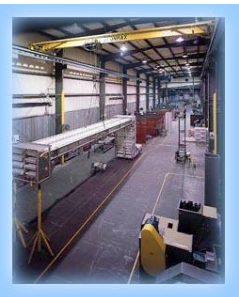

- State-of-the-art testing facility allows customers to actually test their product in use with equipment
- Skilled engineering and sales support staff ensures customer satisfaction
- Strong service department for post-sales support and spare parts



- Robust unit construction for durability and easy installation
- Clean-in-place capabilities for maximum cleanliness
- Multiple cover options to meet specific application needs and ensure safety

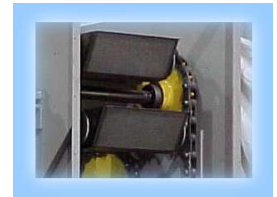
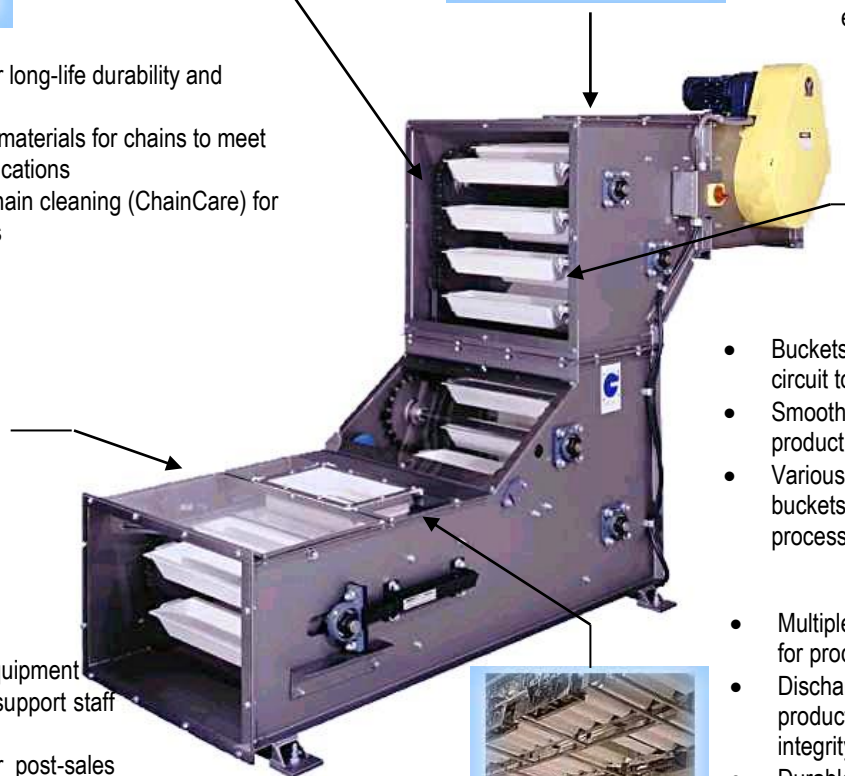

- Buckets remain upright throughout circuit to ensure product integrity
- Smooth bucket surfaces eliminate product trap areas
- Various construction materials for buckets are available to meet specific process requirements



- Multiple feed inlets and discharge points for production capabilities
- Discharges on lower run reducing product free-fall and maintaining product integrity
- Durable, yet gentle, handling of customer's product

Tough, Gentle, Clean

Gough Econ, Inc.

P.O. Box 668583, Charlotte, NC 28266-8583
Phone: 800.264-6844 Fax: 704.392.8706

E-Mail: sales@goughecon.com

Website: www.goughecon.com

Form: swinglink®.doc

Rev 1

Typical Circuit Configurations

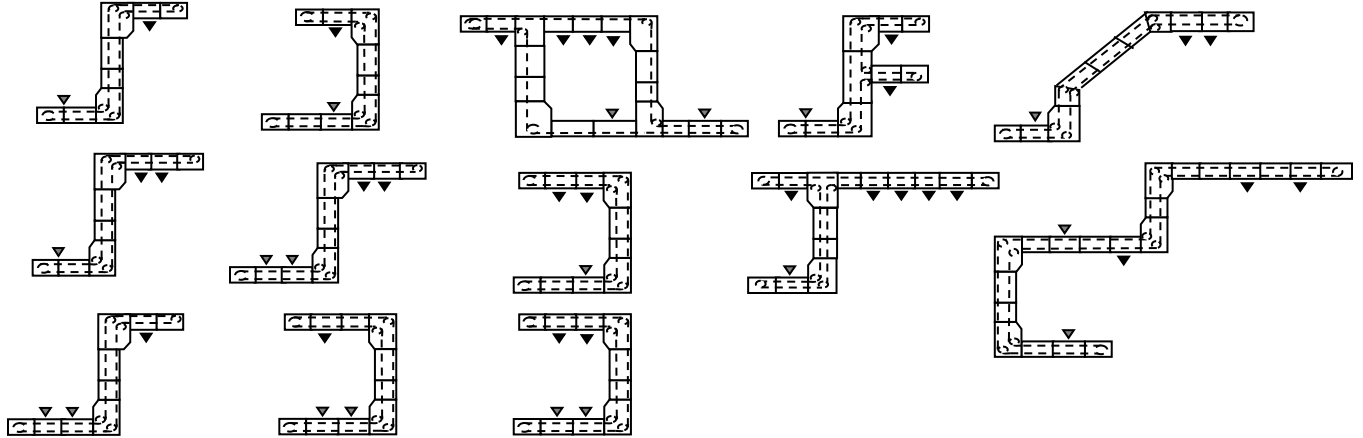

Typical Capacity Chart

Speed (FPM)	BUCKET SIZE								
	S-SERIES		M-SERIES					L-SERIES	
	9" Wide	18" Wide	9" Wide	12" Wide	18" Wide	24" Wide	36" Wide	36" Wide	48" Wide
20	75	145	122	173	267	350	492	801	1047
22	82	160	134	190	294	385	542	881	1152
24	90	175	146	207	320	420	591	962	1256
26	97	189	158	225	347	456	640	1042	1361
28	105	204	171	242	374	491	689	1122	1466
30	112	218	183	259	400	526	739	1202	1570
32	120	233	195	276	427	561	788	1282	1675
34	127	247	207	294	454	596	837	1362	1780
36	135	262	219	311	480	631	886	1442	1884
38	142	276	232	328	507	666	936	1523	1989
40	150	291	244	346	534	701	985	1603	2094
42	157	305	256	363	560	736	1034	1683	2198
44	165	320	268	380	587	771	1083	1763	2303
46	172	335	280	397	614	806	1133	1843	2408
48	180	349	293	415	641	841	1182	1923	2513
50	187	364	305	432	667	876	1231	2003	2617
52	195	378	317	449	694	911	1280	2084	2722
54	202	393	329	467	721	946	1330	2164	2827
56	210	407	341	484	747	981	1379	2244	2931
58	217	422	354	501	774	1016	1428	2324	3036
60	225	436	366	518	801	1051	1477	2404	3141

1. Based on 60% fill. Throughput is defined as cubic feet per hour.

Tough, Gentle, Clean

Gough Econ, Inc.

P.O. Box 668583, Charlotte, NC 28266-8583

Phone: 800.264-6844 Fax: 704.392.8706

E-Mail: sales@goughecon.com

Website: www.goughecon.com

Form: swinglink®.doc

Rev 1



Swinglink® Bucket Elevators

Typical Engineering Data

Construction:

Tubular, open, folded construction, or totally enclosed designs available.

Construction Materials: 11-gauge folded steel side panels with 14-gauge steel, stainless steel, or lexan cover panels.

All elevators are covered up to 7'-0" for safety purposes.

Bucket Design:

Sizes: "S" Series: 6", 9", 12", 18" wide
"M" Series: 9", 12", 18", 24", 30", 36" wide
"L" Series: 18", 24", 30", 36", 42", 48" wide

Pitch: "S" Series: 6" centers
"M" Series: 9" centers
"L" Series: 12" centers

Construction Materials: Carbon steel, stainless steel, or polypropylene. (Note: 6" bucket for "S" Series is not available in plastic.)

Bucket pins: Stainless steel type 303

Tipping mechanism: Individually replaceable "teardrop" and/or "T" cam. 360° rotations

Chain Design:

"S" Series: C.S. -1.5" pitch
S.S. - 1.5" pitch

"M" Series: C.S. -3" pitch
S.S. -3" pitch
Plastic - 3" pitch

"L" Series: C.S. -3" pitch
S.S. -3" pitch
Plastic - 3" pitch

Construction Materials: Acetal plastic, carbon steel, or stainless steel

Sprocket & Shaft Design:

Easily removed sprockets made from steel (for steel chains) or a polymeric compound (for plastic chains).

Sprocket/shaft bearing:

Sealed flange bearing

Lubrication:

Lubrication required on CS & SS chains. (Lubrication used depends on application)
No lubrication required on plastic chain.

Temperature:

-22 °F (-30 °C) up to 230 °F (110 °C)
120 °F highest recommended temperature for plastic buckets.

Finish:

Steel It™ air dry polyurethane

In-Feed Options:

Controlled in-feed recommended
Multiple in-feed option available

Discharge Options:

"Over the end" discharge
Single or multiple discharge(s)
anywhere in circuit available

Drives:

Drive HP, voltage, etc. dependent on application. Motor drives into a gearbox, which is then transferred via transmission chain and sprockets. A torque limiter provides protection to elevator main chains and components.

Tough, Gentle, Clean

Gough Econ, Inc.

P.O. Box 668583, Charlotte, NC 28266-8583

Phone: 800.264-6844 Fax: 704.392.8706

E-Mail: sales@goughecon.com

Website: www.goughecon.com

Form: swinglink®.doc

Rev 1

Typical Operating Description:

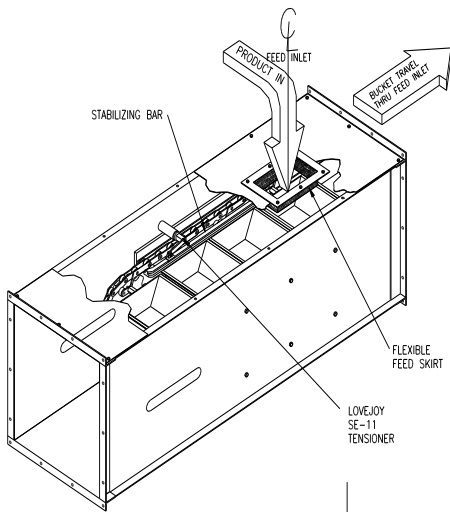

Over-the-end discharge is available.

Single or multiple discharges anywhere in circuit are available.

Standard design provides for in-feed on top run of buckets; however, other in-feed designs are available.

Multiple in-feed options are available.

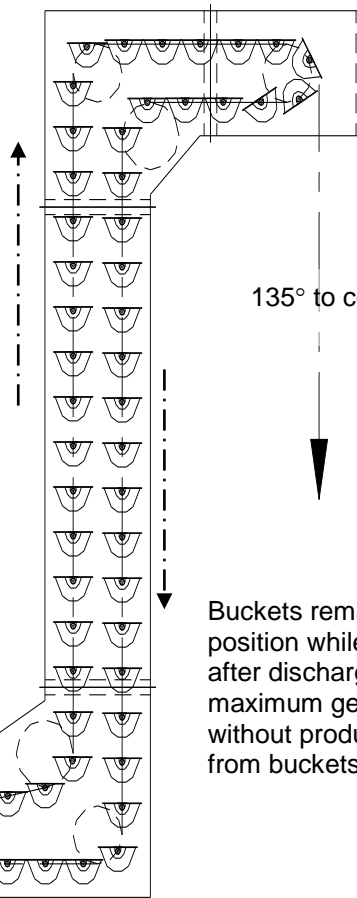

135° to complete 360° rotation as required.

Buckets remain in upright position while loading and after discharge. This allows maximum gentle handling without product free falling from buckets.

Buckets overlap in the horizontal position to prevent product spillage during loading.

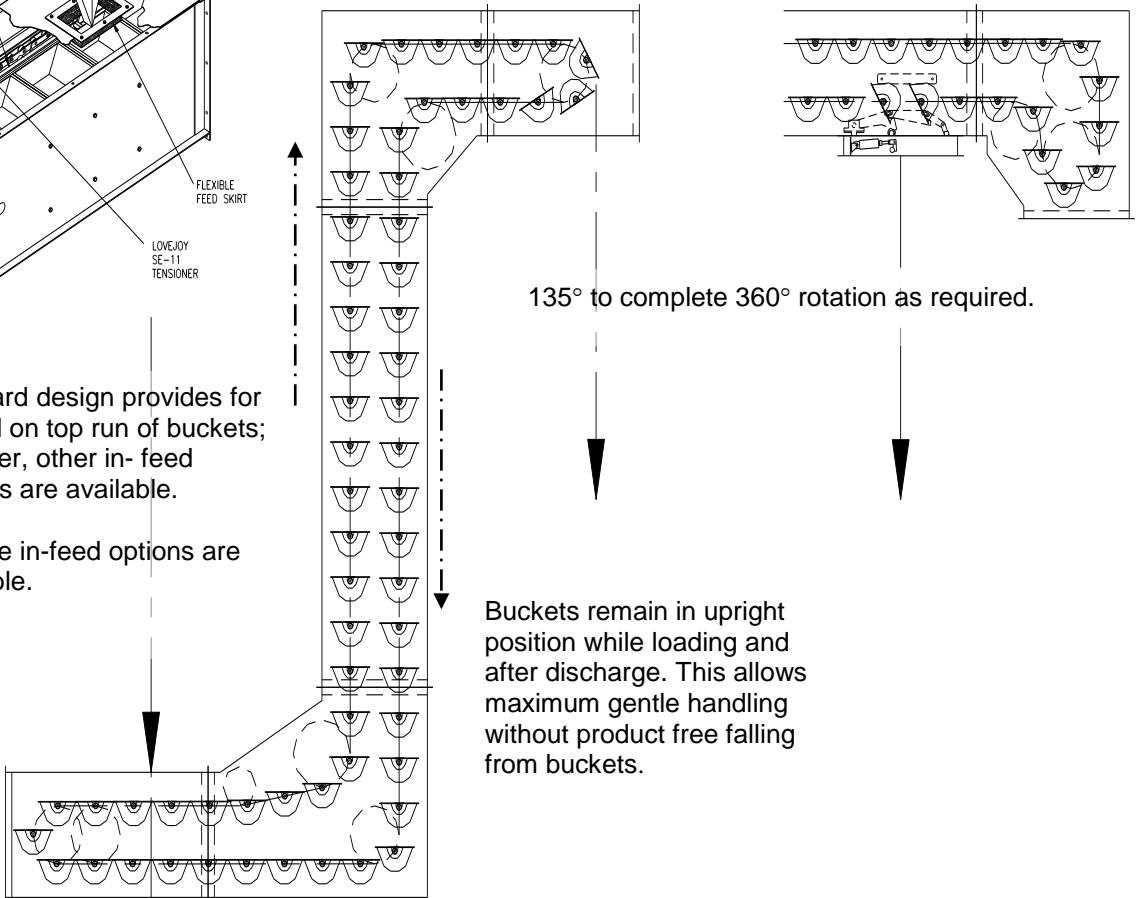

Tough, Gentle, Clean